

SOT-23 Plastic-Encapsulate Transistors

Features

- Low $V_{CE(sat)}$. $V_{CE(sat)} = -0.2V$ $V_{CE(sat)} = -0.2V$
- High breakdown voltage. $BV_{CEO} = -80V$

MECHANICAL DATA

- Case style: SOT-23 molded plastic
- Mounting position: any

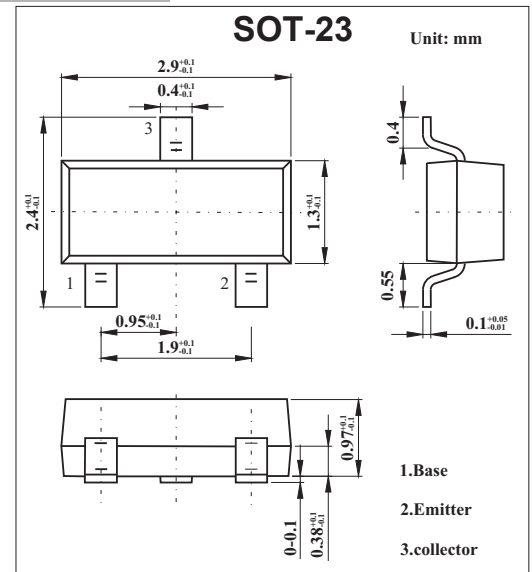

MAXIMUM RATINGS AND CHARACTERISTICS

@ 25°C Ambient Temperature (unless otherwise noted)

Parameter	Symbol	Rating	Unit
Collector - Base Voltage	V_{CB0}	-80	V
Collector - Emitter Voltage	V_{CE0}	-80	
Emitter - Base Voltage	V_{EB0}	-5	
Collector Current	I_C	-0.5	A
Collector Power Dissipation	P_c	0.2	W
Junction Temperature	T_J	150	°C
Storage Temperature range	T_{stg}	-55 to 150	

PACKAGE INFORMATION

Device	Package	Shipping
2SB1198	SOT-23	3000/Tape&Reel

Parameter	Symbol	Test conditions	Min	Typ	Max	Unit
Collector- base breakdown voltage	V_{CB0}	$I_C = -50 \mu A, I_E = 0$	-80			V
Collector- emitter breakdown voltage	V_{CE0}	$I_C = -2 mA, I_B = 0$	-80			
Emitter - base breakdown voltage	V_{EB0}	$I_E = -50 \mu A, I_C = 0$	-5			
Collector-base cut-off current	I_{CBO}	$V_{CB} = -50 V, I_E = 0$			-0.5	μA
Emitter cut-off current	I_{EBO}	$V_{EB} = -4V, I_C = 0$			-0.5	
DC current gain	h_{FE}	$V_{CE} = -3V, I_C = -100mA$	120		390	
Collector-emitter saturation voltage	$V_{CE(sat)}$	$I_C = -0.5A, I_B = -50mA$		-0.2	-0.5	V
Collector output capacitance	C_{ob}	$V_{CB} = 10V, I_E = 0mA, f = 1MHz$		11		pF
Transition frequency	f_T	$V_{CE} = -10V, I_E = 50mA, f = 100MHz$		180		MHz

Classification of $h_{FE(1)}$

Rank	AKQ	AKR
h_{FE}	120-270	180-390

■ Typical Characteristics

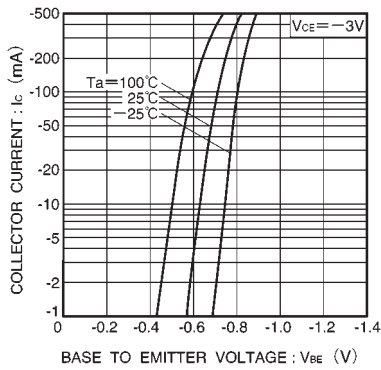

Fig.1 Grounded emitter propagation characteristics

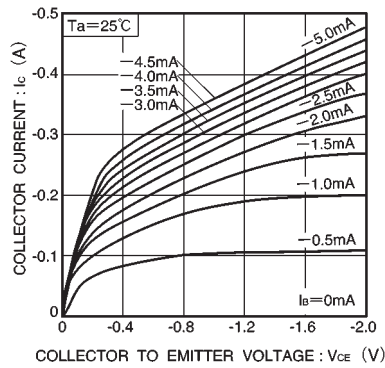

Fig.2 Grounded emitter output characteristics

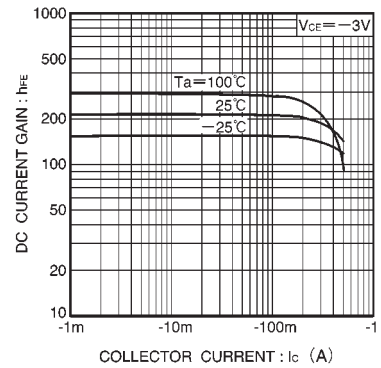

Fig.3 DC current gain vs. collector current

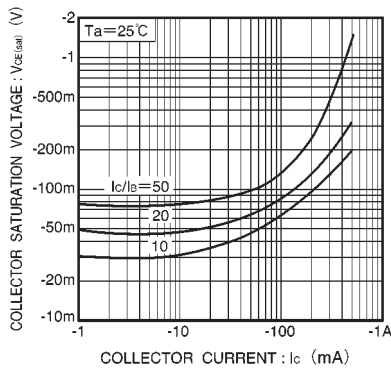

Fig.4 Collector-emitter saturation voltage vs. collector current (I)

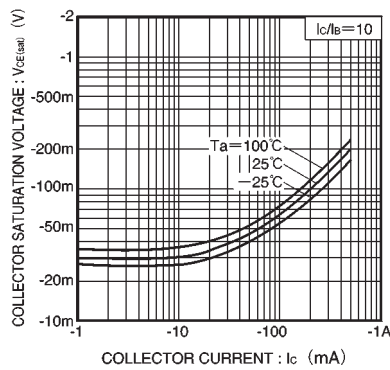

Fig.5 Collector-emitter saturation voltage vs. collector current (II)

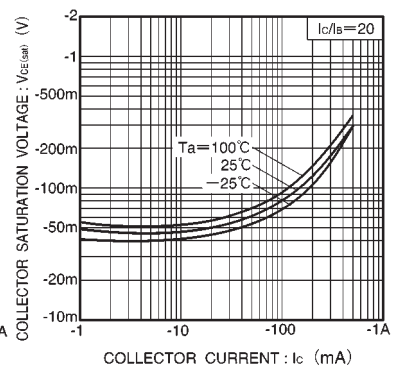

Fig.6 Collector-emitter saturation voltage vs. collector current (III)

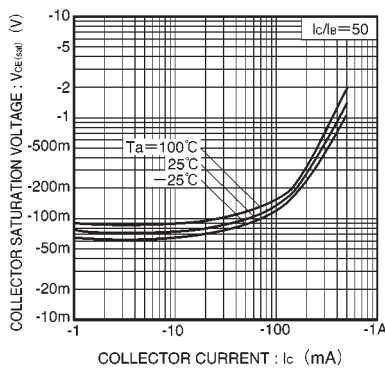

Fig.7 Collector-emitter saturation voltage vs. collector current (IV)

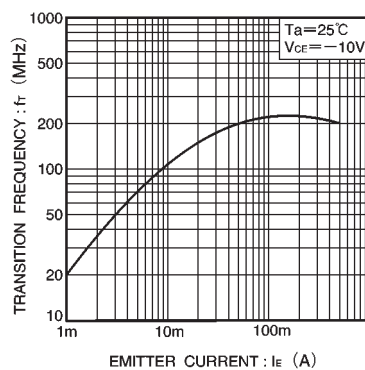

Fig.8 Gain bandwidth product vs. emitter current

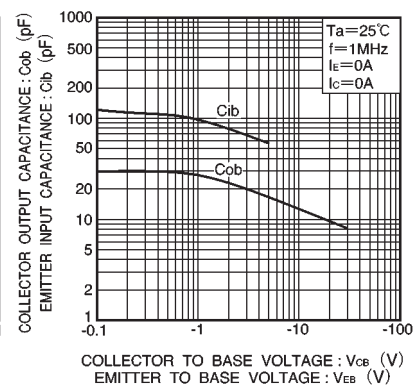

Fig.9 Collector output capacitance vs. collector-base voltage
Emitter input capacitance vs. emitter-base voltage