

## SOT-89 Plastic-Encapsulate Transistors

### Features

- High breakdown voltage and high current.
- Low collector-emitter saturation voltage  $V_{CE(sat)}$
- Good  $h_{FE}$  linearity.
- Complementary to 2SD1898
- PNP Transistors

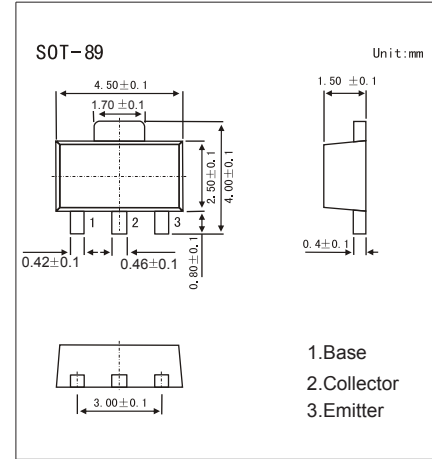

Parameter	Symbol	Rating	Unit
Collector - Base Voltage	$V_{CBO}$	-80	V
Collector - Emitter Voltage	$V_{CEO}$	-80	
Emitter - Base Voltage	$V_{EBO}$	-5	
Collector Current - Continuous	$I_C$	-1	A
Collector current -Pulse	$I_{CP}$	-2	
Collector Power Dissipation	$P_C$	0.5	W
		2	
Junction Temperature	$T_J$	150	°C
Storage Temperature range	$T_{stg}$	-55 to 150	

Parameter	Symbol	Test Conditions	Min	Typ	Max	Unit
Collector- base breakdown voltage	$V_{CBO}$	$I_C = -100 \mu A, I_E = 0$	-80			V
Collector- emitter breakdown voltage	$V_{CEO}$	$I_C = -1 mA, I_B = 0$	-80			
Emitter - base breakdown voltage	$V_{EBO}$	$I_E = -100 \mu A, I_C = 0$	-5			
Collector-base cut-off current	$I_{CBO}$	$V_{CB} = -60V, I_E = 0$			-1	$\mu A$
Emitter cut-off current	$I_{EBO}$	$V_{EB} = -4V, I_C = 0$			-1	
Collector-emitter saturation voltage	$V_{CE(sat)}$	$I_C = -500 mA, I_B = -50mA$			-0.4	V
Base - emitter saturation voltage	$V_{BE(sat)}$	$I_C = -500 mA, I_B = -50mA$			-1.2	
DC current gain	$h_{FE}$	$V_{CE} = -3V, I_C = -100 mA$	120		390	
Collector output capacitance	$C_{ob}$	$V_{CB} = -10V, I_E = 0, f = 1MHz$		20		pF
Transition frequency	$f_T$	$V_{CE} = -10V, I_E = 50mA, f = 100MHz$		100		MHz

### Classification of $h_{FE}$

Type	2SB1260-Q	2SB1260-R
Range	120-270	180-390
Marking	BE Q*	BE R*

# RATINGS AND CHARACTERISTIC CURVES

## ■ Typical Characteristics

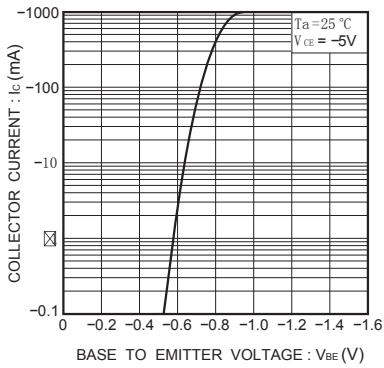

Fig.1 Grounded emitter propagation characteristics

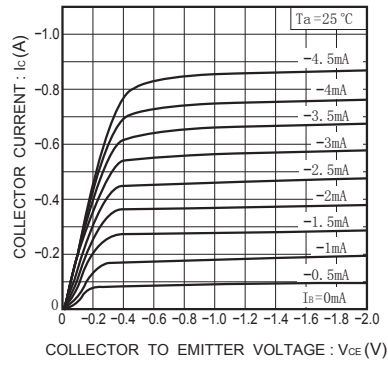

Fig.2 Grounded emitter output characteristics

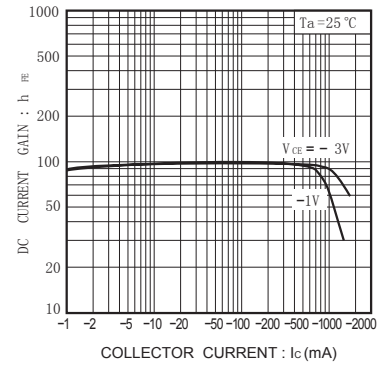

Fig.3 DC current gain vs. collector current

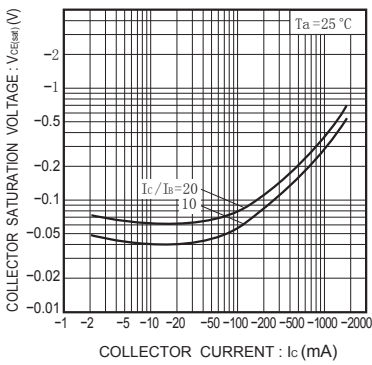

Fig.4 Collector-emitter saturation voltage vs. collector current

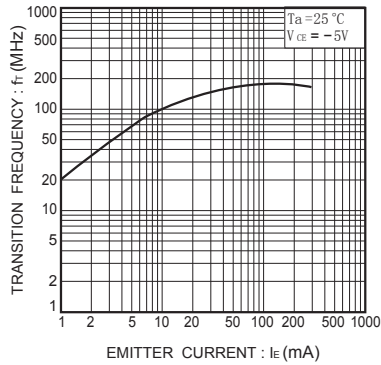

Fig.5 Gain bandwidth product vs. emitter current

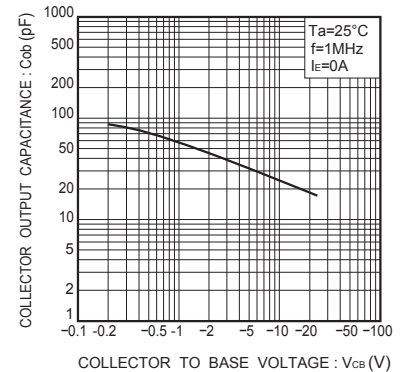

Fig.6 Collector output capacitance vs. collector-base voltage