

Three-terminal positive voltage regulator

FEATURES

- Maximum output current I_{OM}: 0.1A
- Output voltage V_O: 8V
- Continuous total dissipation
P_D: 0.625 W (T_a= 25)

MECHANICAL DATA

- Case: TO-92 Small Outline Plastic Package
- Polarity: Color band denotes cathode end
- Mounting Position: Any

TO-92

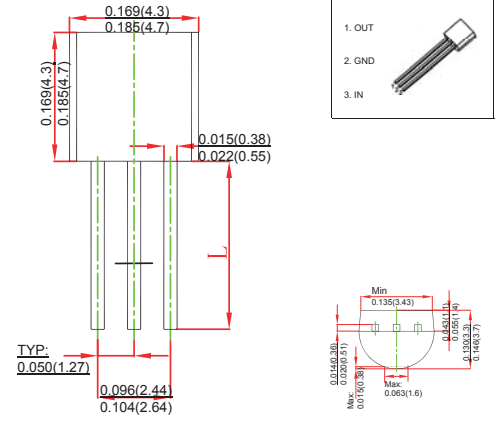

MAXIMUM RATINGS AND CHARACTERISTICS

@ 25°C Ambient Temperature (unless otherwise noted)

Parameter	Symbol	Value	Unit
Input Voltage	V _i	30	V
Thermal Resistance from Junction to Ambient	R _{θJA}	160	°C/W
Operating Junction Temperature Range	T _{OPR}	-25~+125	°C
Storage Temperature Range	T _{STG}	-65~+150	°C

ELECTRICAL CHARACTERISTICS AT SPECIFIED VIRTUAL JUNCTION TEMPERATURE

(V_i=14V, I_o=40mA, C_i=0.33 F, C_o=0.1 F, unless otherwise specified)

Parameter	Symbol	Test conditions	Min	Typ	Max	Unit	
Output voltage	V _O	25°C	7.7	8.0	8.3	V	
		0-125°C	10.5V ≤ V _i ≤ 23V, I _o =1mA~40mA	7.6	8.0	8.4	V
			I _o =1mA~70mA	7.6	8.0	8.4	V
Load Regulation	ΔV _O	I _o =1mA~100mA	25°C	18	80	mV	
		I _o =1mA~40mA	25°C	10	40	mV	
Line regulation	ΔV _O	10.5V ≤ V _i ≤ 23V	25°C	42	175	mV	
		11V ≤ V _i ≤ 23V	25°C	36	125	mV	
Quiescent Current	I _q	25°C		4	6	mA	
Quiescent Current Change	ΔI _q	11V ≤ V _i ≤ 23V	0-125°C		1.5	mA	
		1mA ≤ I _o ≤ 40mA	0-125°C		0.1	mA	
Output Noise Voltage	V _N	10Hz ≤ f ≤ 100KHz	25°C	54		μV/V _O	
Ripple Rejection	RR	13V ≤ V _i ≤ 23V, f=120Hz	0-125°C	37	46	dB	
Dropout Voltage	V _d	25°C		1.7		V	

* Pulse test.

TYPICAL APPLICATION

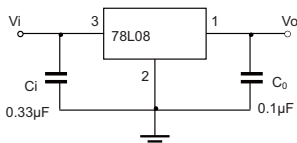

Note: Bypass capacitors are recommended for optimum stability and transient response and should be located as close as possible to the regulators.

Typical Characteristics

Output Characteristics

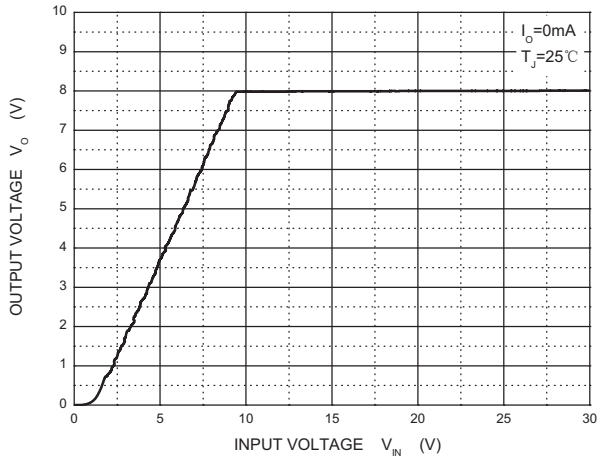

Dropout Characteristics

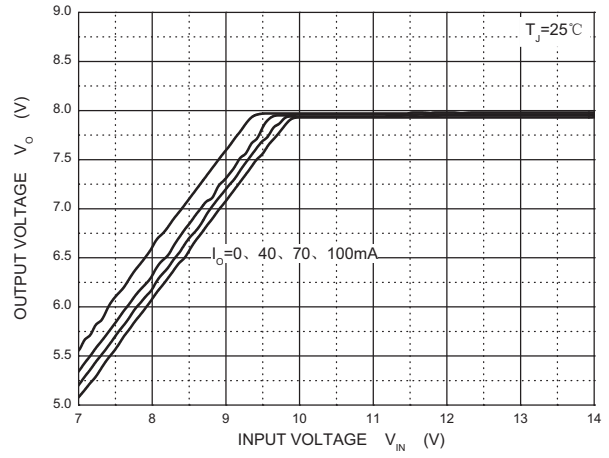

Quiescent Current vs Input Voltage

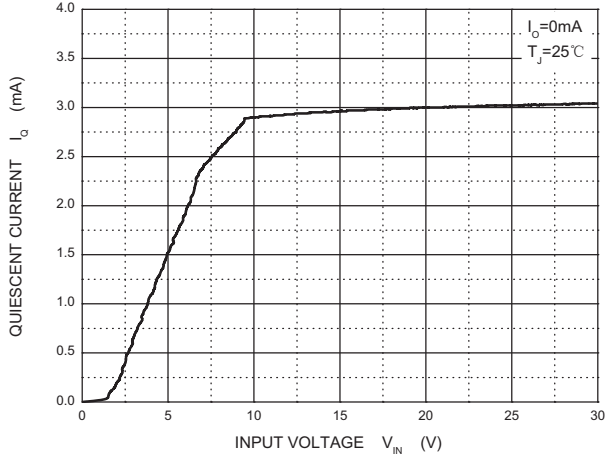

Current Cut-off Grid Voltage

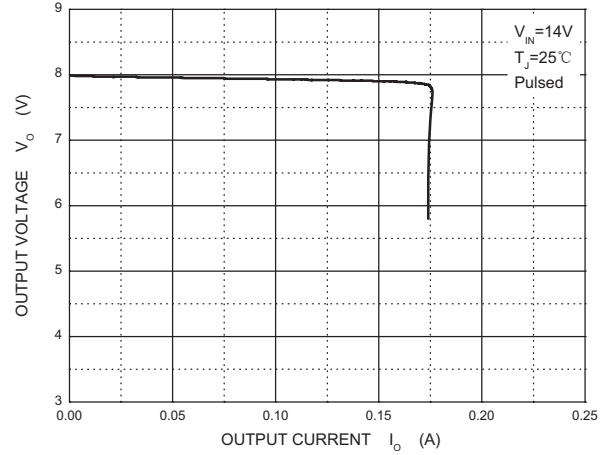

Output Voltage vs Junction Temperature

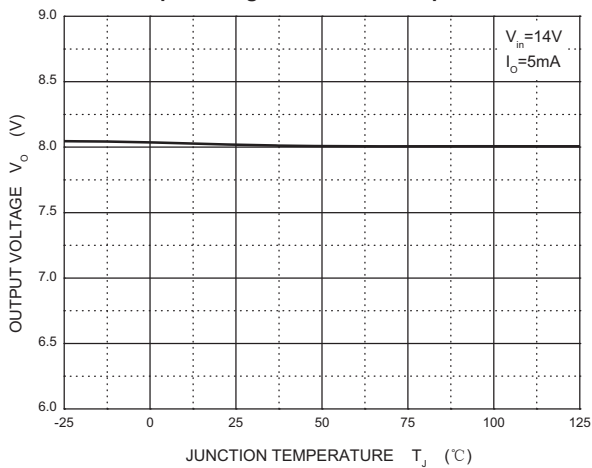

Power Derating Curve

