

A44 TRANSISTOR (NPN)

FEATURES

- Low Collector-Emitter Saturation Voltage
- High Breakdown Voltage

Symbol	Parameter	Value	Unit
V_{CBO}	Collector-Base Voltage	400	V
V_{CEO}	Collector-Emitter Voltage	400	V
V_{EBO}	Emitter-Base Voltage	6	V
I_C	Collector Current -Continuous	200	mA
I_{CM}	Collector Current -Pulsed	300	mA
P_C	Collector Power Dissipation	500	mW
$R_{\theta JA}$	Thermal Resistance from Junction to Ambient	250	°C/W
T_j	Junction Temperature	150	°C
T_{stg}	Storage Temperature	-55~+150	°C

Parameter	Symbol	Test conditions	Min	Typ	Max	Unit
Collector-base breakdown voltage	$V_{(BR)CBO}$	$I_C=100\mu A, I_E=0$	400			V
Collector-emitter breakdown voltage	$V_{(BR)CEO}^*$	$I_C=1mA, I_B=0$	400			V
Emitter-base breakdown voltage	$V_{(BR)EBO}$	$I_E=10\mu A, I_C=0$	6			V
Collector cut-off current	I_{CBO}	$V_{CB}=400V, I_E=0$			0.1	μA
Emitter cut-off current	I_{EBO}	$V_{EB}=4V, I_C=0$			0.1	μA
DC current gain	$h_{FE(1)}^*$	$V_{CE}=10V, I_C=1mA$	40			
	$h_{FE(2)}^*$	$V_{CE}=10V, I_C=10mA$	50		200	
	$h_{FE(3)}^*$	$V_{CE}=10V, I_C=50mA$	45			
	$h_{FE(4)}^*$	$V_{CE}=10V, I_C=100mA$	40			
Collector-emitter saturation voltage	$V_{CE(sat)}^*$	$I_C=1mA, I_B=0.1mA$			0.4	V
		$I_C=10mA, I_B=1mA$			0.5	V
		$I_C=50mA, I_B=5mA$			0.75	V
Base-emitter saturation voltage	$V_{BE(sat)}^*$	$I_C=10mA, I_B=1mA$			0.75	V
Collector output capacitance	C_{ob}	$V_{CB}=20V, I_E=0, f=1MHz$			7	pF
Emitter input capacitance	C_{ib}	$V_{BE}=0.5V, I_C=0, f=1MHz$			130	pF

*Pulse test: pulse width $\leq 300\mu s$, duty cycles $\leq 2.0\%$.

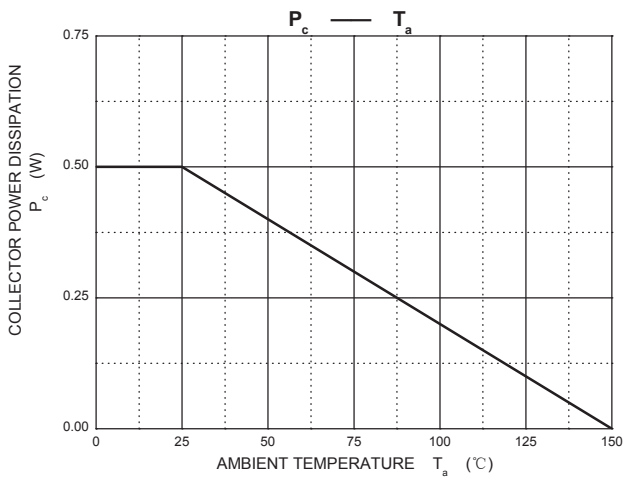
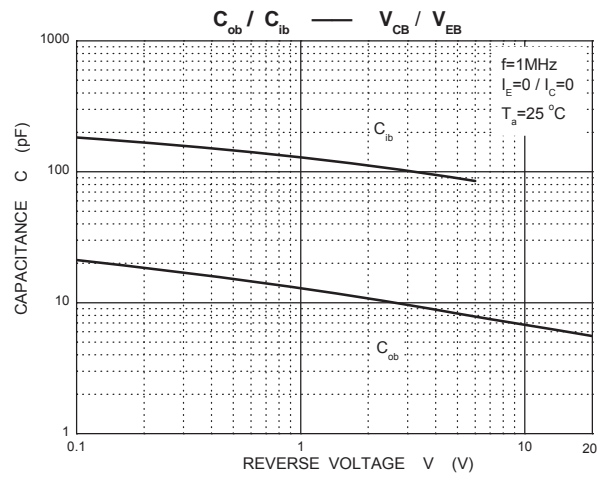
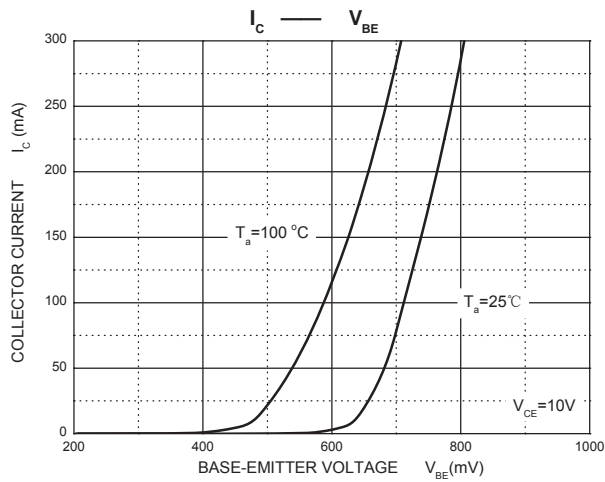
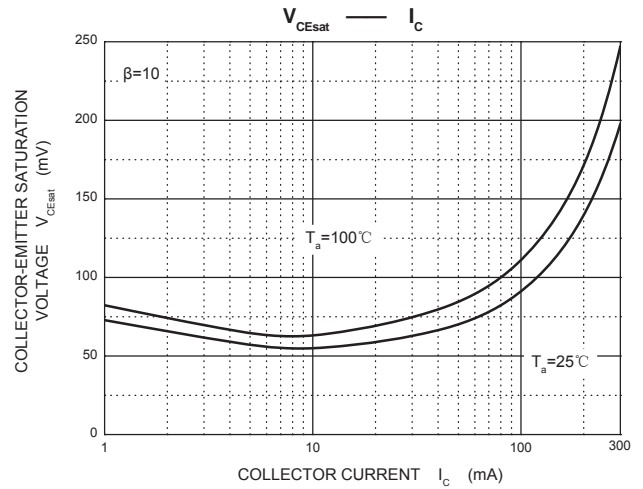
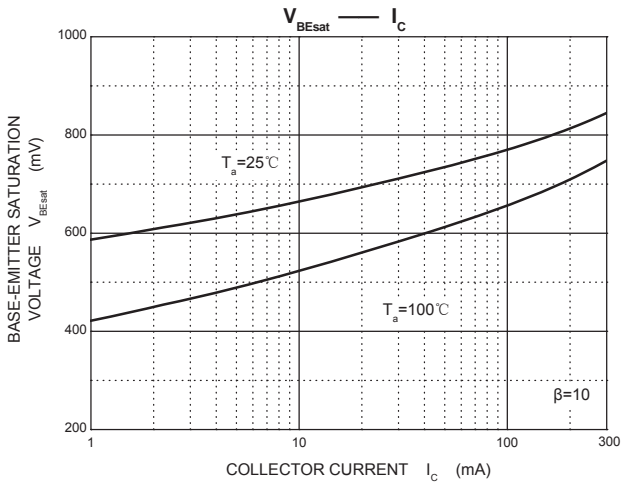
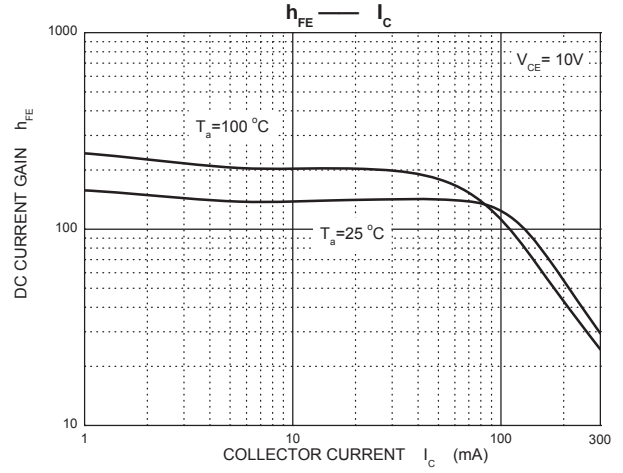
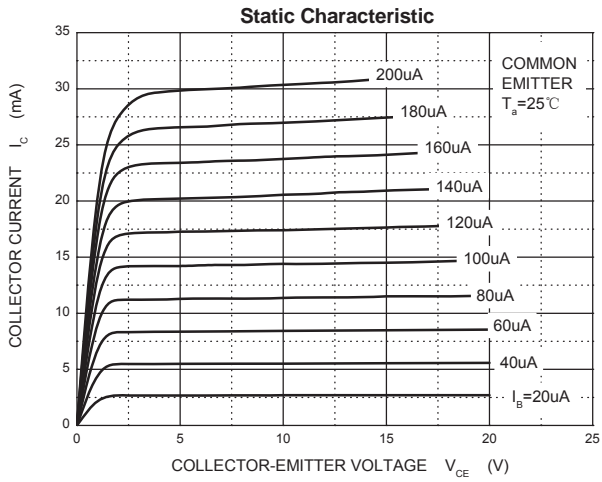

SOT-89-3L Tape and Reel

SOT-89-3L Embossed Carrier Tape

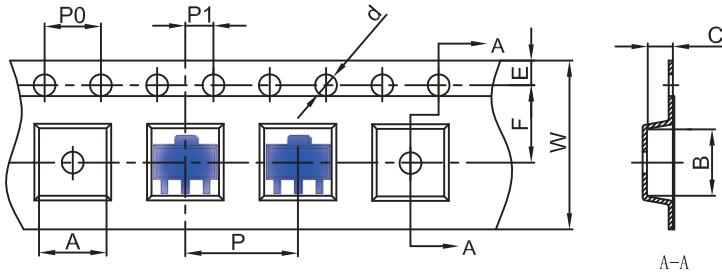

Packaging Description:
 SOT-89-3L parts are shipped in tape. The carrier tape is made from a dissipative (carbon filled) polycarbonate resin. The cover tape is a multilayer film (Heat Activated Adhesive in nature) primarily composed of polyester film, adhesive layer, sealant, and anti-static sprayed agent. These reeled parts in standard option are shipped with 1,000 units per 7" or 18.0 cm diameter reel. The reels are clear in color and is made of polystyrene plastic (anti-static coated).

Dimensions are in millimeter										
Pkg type	A	B	C	d	E	F	P0	P	P1	W
SOT-89-3L	4.85	4.45	1.85	Ø1.50	1.75	5.50	4.00	8.00	2.00	12.00

SOT-89-3L Tape Leader and Trailer

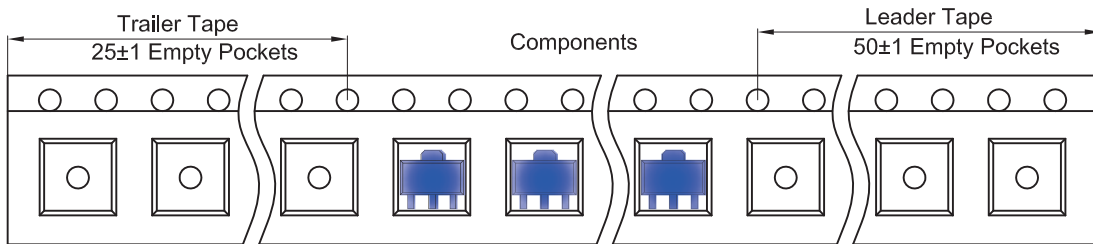

SOT-89-3L Reel

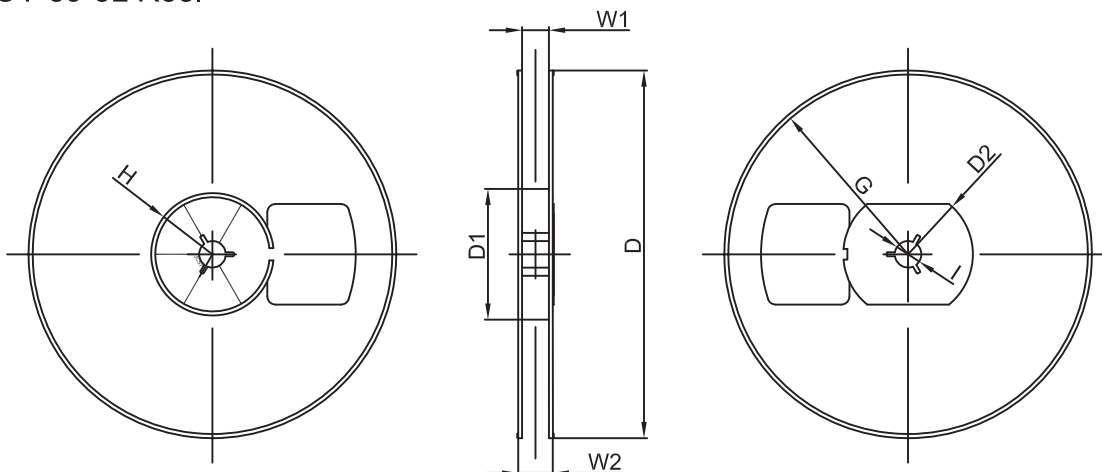

Dimensions are in millimeter								
Reel Option	D	D1	D2	G	H	I	W1	W2
7" Dia	Ø180.00	60.00	R32.00	R86.50	R30.00	Ø13.00	13.20	16.50

REEL	Reel Size	Box	Box Size(mm)	Carton	Carton Size(mm)	G.W.(kg)
1000 pcs	7 inch	10,000 pcs	203×203×195	40,000 pcs	438×438×220	