

PPAK5X6 Pin Configuration

BVDSS	R _{DS(ON)}	I _D
150V	19mΩ	65A

FEATURES

- 150V,65A, R_{DS(ON)} =19mΩ @V_{GS} = 10V
- Improved dv/dt capability
- Fast switching
- 100% EAS Guaranteed
- Green Device Available
- N-Channel MOSFETS

APPLICATIONS

- Networking
- Load Switch
- LED applications
- Quick Charger

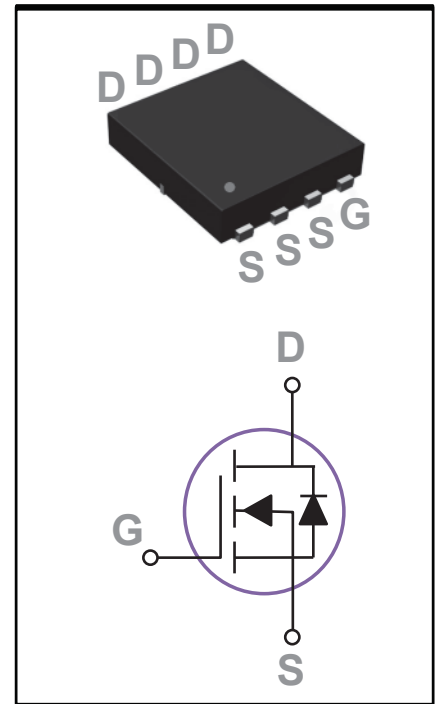
MAXIMUM RATINGS AND CHARACTERISTICS

@ 25°C Ambient Temperature (unless otherwise noted)

Parameter	Symbol	Rating	Unit
Drain-Source Voltage	V _{DS}	150	V
Gate-Source Voltage	V _{GS}	±20	V
Drain Current – Continuous (T _C =25°C)	I _D	65	A
Drain Current – Continuous (T _C =100°C)		41	A
Drain Current – Pulsed ¹	I _{DM}	260	A
Single Pulse Avalanche Energy ²	EAS	153	mJ
Single Pulse Avalanche Current ²	IAS	17.5	A
Power Dissipation (T _C =25°C)	P _D	192	W
Power Dissipation – Derate above 25°C		1.54	W/°C
Storage Temperature Range	T _{STG}	-55 to +150	°C
Operating Junction Temperature Range	T _J	-55 to +150	°C

Parameter	Symbol	Typ.	Max.	Unit
Thermal Resistance Junction to ambient	R _{θJA}	---	62	°C/W
Thermal Resistance Junction to Case	R _{θJC}	---	0.65	°C/W

PPAK5X6 Pin Configuration
Off Characteristics

Parameter	Symbol	Conditions	Min.	Typ.	Max.	Unit
Drain-Source Breakdown Voltage	BV_{DSS}	$V_{GS}=0V, I_D=250\mu A$	150	---	---	V
Drain-Source Leakage Current	I_{DSS}	$V_{DS}=120V, V_{GS}=0V, T_J=25^\circ C$	---	---	1	μA
		$V_{DS}=120V, V_{GS}=0V, T_J=85^\circ C$	---	---	10	μA
Gate-Source Leakage Current	I_{GSS}	$V_{GS}=\pm 20V, V_{DS}=0V$	---	---	± 100	nA

On Characteristics

Static Drain-Source On-Resistance ³	$R_{DS(ON)}$	$V_{GS}=10V, I_D=25A$	---	16	19	m Ω
Gate Threshold Voltage	$V_{GS(th)}$	$V_{GS}=V_{DS}, I_D=250\mu A$	2	3	4	V
Forward Transconductance	gfs	$V_{DS}=10V, I_D=3A$	---	11	---	S

Dynamic and switching Characteristics

Total Gate Charge ^{3, 4}	Q_g	$V_{DS}=75V, V_{GS}=10V, I_D=30A$	---	39	60	nC
Gate-Source Charge ^{3, 4}	Q_{gs}		---	9.5	15	
Gate-Drain Charge ^{3, 4}	Q_{gd}		---	15	23	
Turn-On Delay Time ^{3, 4}	$T_{d(on)}$	$V_{DD}=75V, V_{GS}=10V, R_G=6\Omega, I_D=30A$	---	15	23	ns
Rise Time ^{3, 4}	T_r		---	28	42	
Turn-Off Delay Time ^{3, 4}	$T_{d(off)}$		---	45	68	
Fall Time ^{3, 4}	T_f		---	32	48	
Input Capacitance	C_{iss}	$V_{DS}=75V, V_{GS}=0V, F=1MHz$	---	2300	3450	pF
Output Capacitance	C_{oss}		---	220	330	
Reverse Transfer Capacitance	C_{rss}		---	10	15	
Gate Resistance	R_g	$V_{GS}=0V, V_{DS}=0V, F=1MHz$	---	1.5	---	Ω

Drain-Source Diode Characteristics and Maximum Ratings

Parameter	Symbol	Conditions	Min.	Typ.	Max.	Unit
Continuous Source Current	I_S	$V_G=V_D=0V, \text{Force Current}$	---	---	65	A
Pulsed Source Current	I_{SM}		---	---	130	A
Diode Forward Voltage	V_{SD}	$V_{GS}=0V, I_S=1A, T_J=25^\circ C$	---	---	1	V
Reverse Recovery Time ³	t_{rr}	$V_R=100V, I_S=10A$ $di/dt=100A/\mu s, T_J=25^\circ C$	---	90	---	ns
Reverse Recovery Charge ³	Q_{rr}		---	355	---	nC

Note :

1. Repetitive Rating : Pulsed width limited by maximum junction temperature.
2. $V_{DD}=50V, V_{GS}=10V, L=1mH, I_{AS}=17.5A, R_G=25\Omega, \text{Starting } T_J=25^\circ C.$
3. The data tested by pulsed , pulse width $\leq 300\mu s$, duty cycle $\leq 2\%$.
4. Essentially independent of operating temperature.

RATINGS AND CHARACTERISTIC CURVES

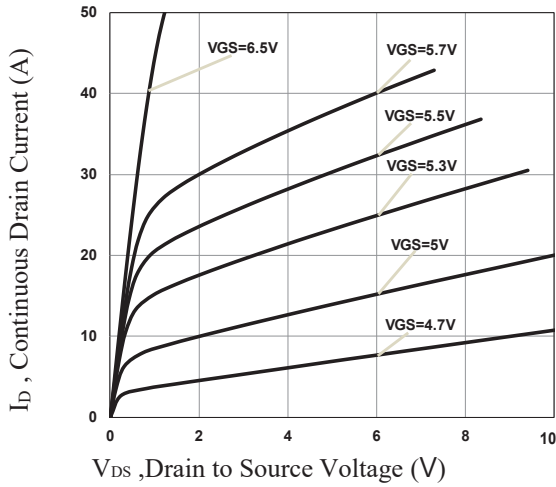

Fig.1 Typical Output Characteristics

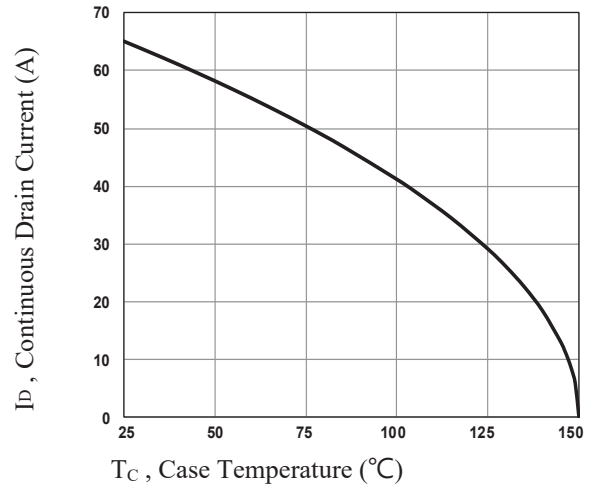

Fig.2 Continuous Drain Current vs. T_c

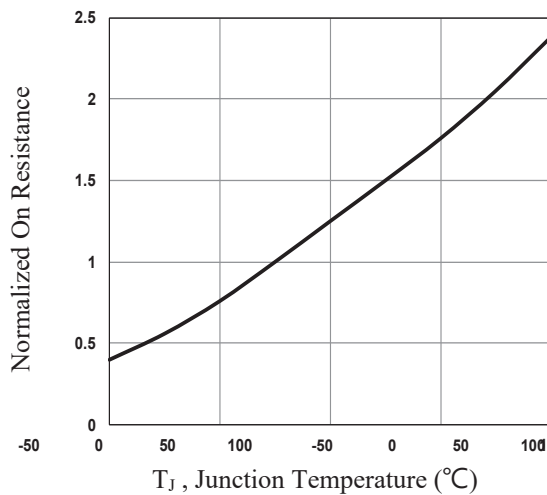

Fig.3 Normalized $R_{DS(on)}$ vs. T_j

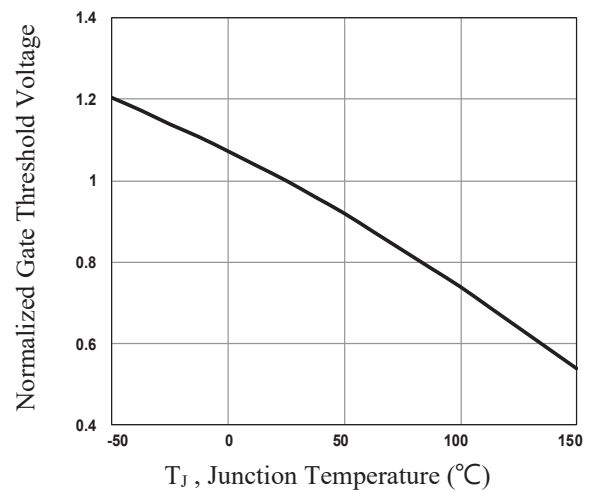

Fig.4 Normalized V_{th} vs. T_j

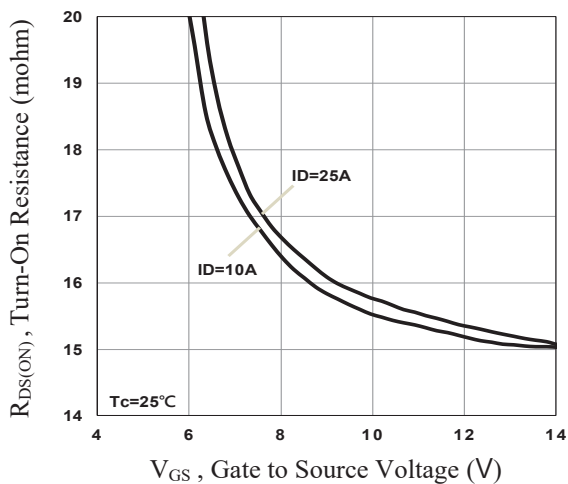

Fig.5 Turn-On Resistance vs. V_{GS}

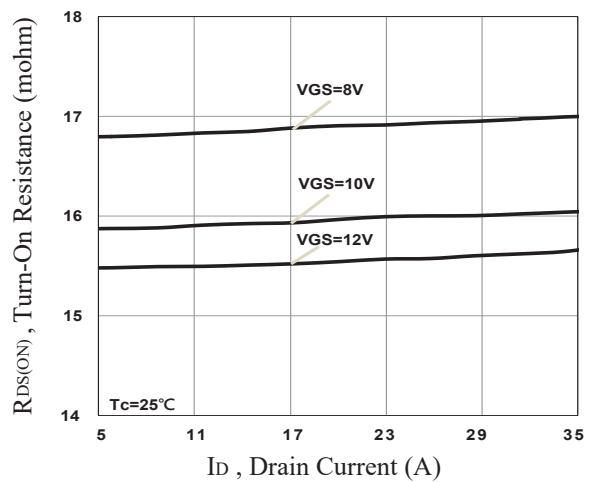

Fig.6 Turn-On Resistance vs. I_D

RATINGS AND CHARACTERISTIC CURVES

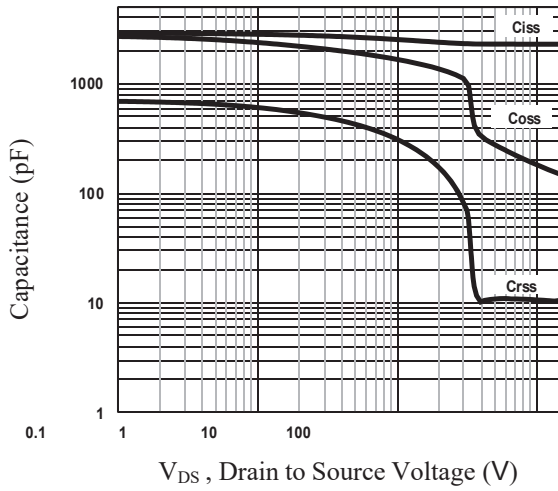

Fig.7 Capacitance Characteristics

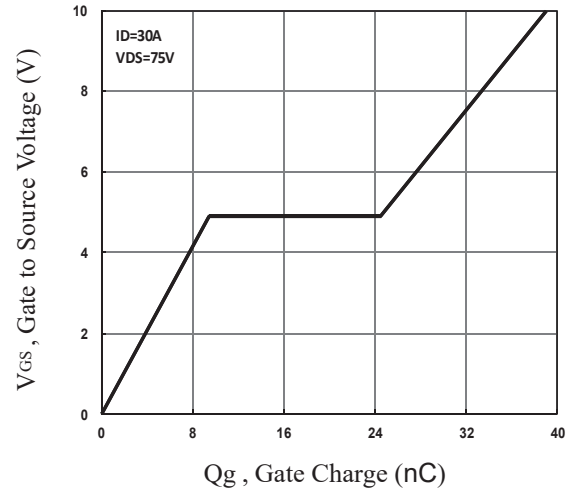

Fig.8 Gate Charge Characteristics

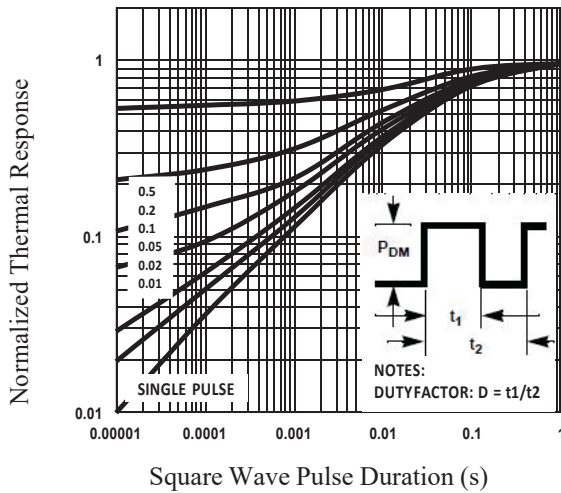

Fig.9 Normalized Transient Impedance

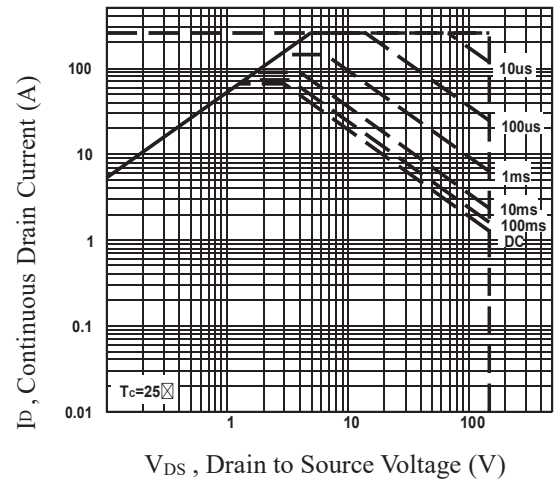

Fig.10 Maximum Safe Operation Area

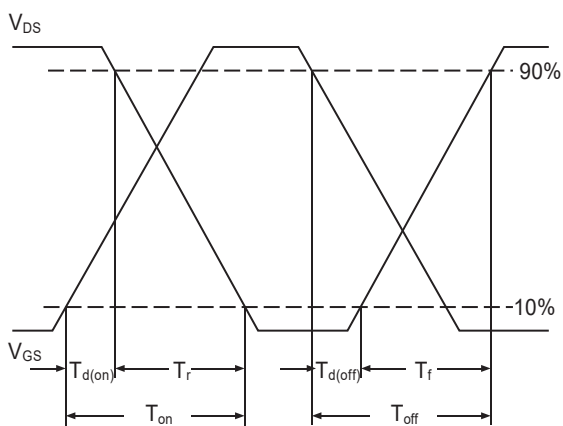

Fig.11 Switching Time Waveform

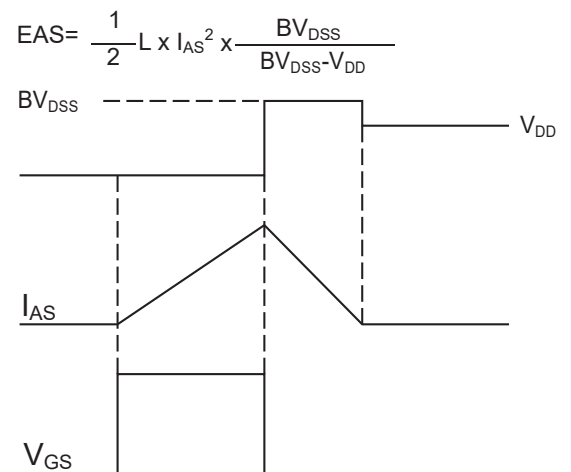
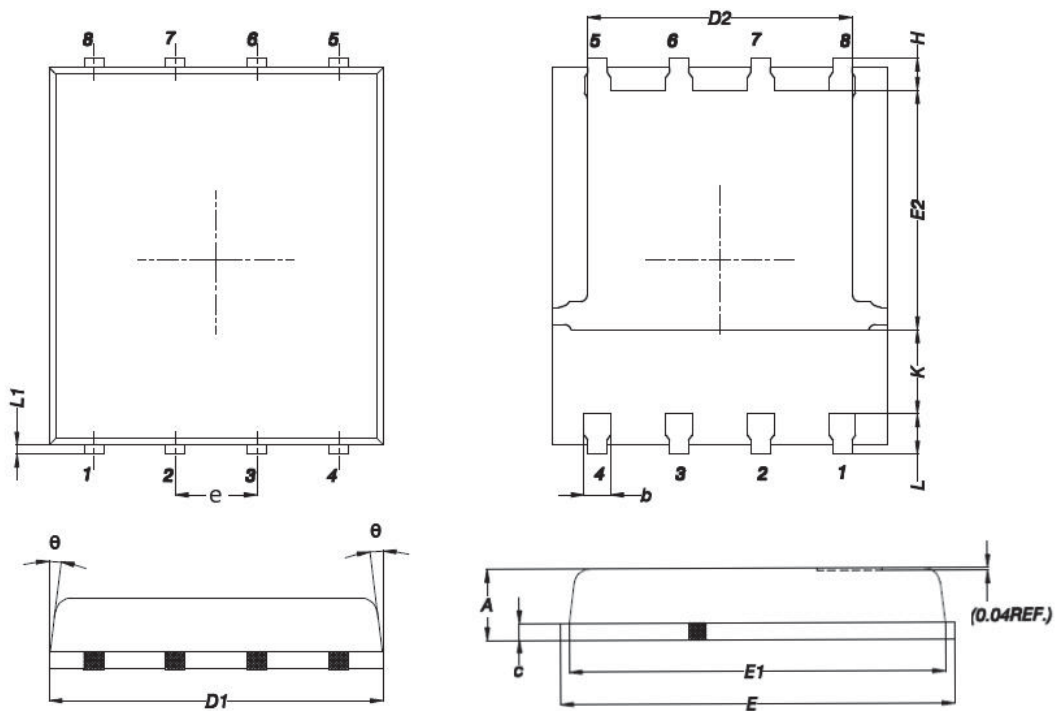

Fig.12 EAS Waveform

PPAK5x6 PACKAGE INFORMATION

Symbol	Dimensions In Millimeters		Dimensions In Inches	
	MAX	MIN	MAX	MIN
A	1.200	0.850	0.047	0.031
b	0.510	0.330	0.020	0.013
C	0.300	0.200	0.012	0.008
D1	5.400	4.800	0.212	0.189
D2	4.310	3.610	0.170	0.142
E	6.300	5.850	0.248	0.230
E1	5.960	5.450	0.235	0.215
E2	3.920	3.300	0.154	0.130
e	1.27BSC		0.05BSC	
H	0.650	0.380	0.026	0.015
K	---	1.100	---	0.043
L	0.710	0.380	0.028	0.015
L1	0.250	0.050	0.009	0.002
θ	12°	0°	12°	0°