

TO-92 Plastic-Encapsulate Transistors

FEATURES

- Darlington Transistor
- TRANSISTOR (NPN)

MECHANICAL DATA

- Case style:TO-92 molded plastic
- Mounting position:any

TO-92

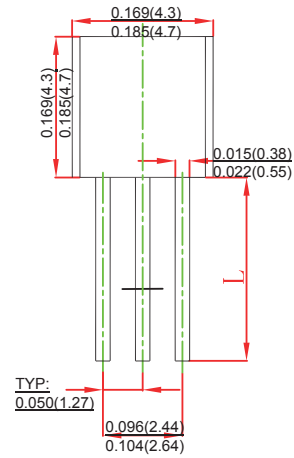

MAXIMUM RATINGS AND CHARACTERISTICS

@ 25°C Ambient Temperature (unless otherwise noted)

Symbol	Parameter	Value	Unit
V _{CB0}	Collector-Base Voltage	30	V
V _{CEO}	Collector-Emitter Voltage	30	V
V _{EBO}	Emitter-Base Voltage	10	V
I _C	Collector Current -Continuous	0.5	A
P _D	Collector Power Dissipation	625	mW
R _{θJA}	Thermal Resistance rom Junction to Ambient	200	°C /W
T _j	Junction Temperature	150	°C
T _{stg}	Storage Temperature	-55~+150	°C

ORDERING INFORMATION

Part Number	Package	Packing Method	Pack Quantity
MPSA14	TO-92	Bulk	1000pcs/Bag
MPSA14-TA	TO-92	Tape	2000pcs/Box

Parameter	Symbol	Test conditions	Min	Typ	Max	Unit
Collector-base breakdown voltage	V _{(BR)CBO}	I _C = 0.1mA, I _E =0	30			V
Collector-emitter breakdown voltage	V _{(BR)CEO}	I _C =1mA, I _B =0	30			V
Emitter-base breakdown voltage	V _{(BR)EBO}	I _E =0.1mA, I _C =0	10			V
Collector cut-off current	I _{CBO}	V _{CB} =30V, I _E =0			0.1	KA
Emitter cut-off current	I _{EBO}	V _{EB} =10V, I _C =0			0.1	KA
DC current gain	h _{FE(1)} *	V _{CE} =5V, I _C =10mA	10000			
	h _{FE(2)} *	V _{CE} =5V, I _C =100mA	20000			
Collector-emitter saturation voltage	V _{CE(sat)} *	I _C =100mA, I _B =0.1mA			1.5	V
Base-emitter voltage	V _{BE} *	V _{CE} =5V, I _C =100mA			2.0	V
Transition frequency	f _T	V _{CE} =5V, I _C =10mA, f=100MHz	125			MHz

*Pulse test: pulse width ^Y300Ks, duty cycle^Y 2.0%.

Marking	MPSA14
---------	--------

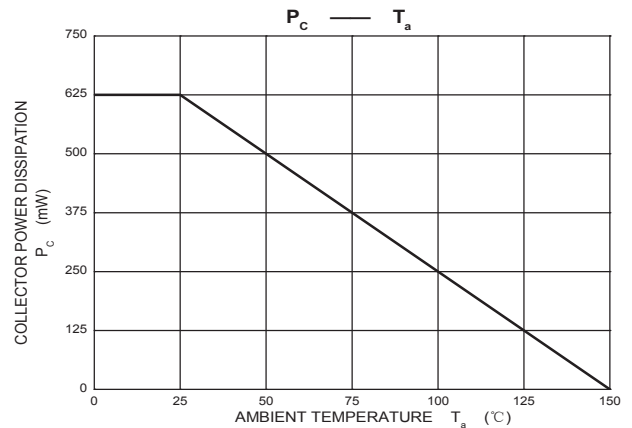
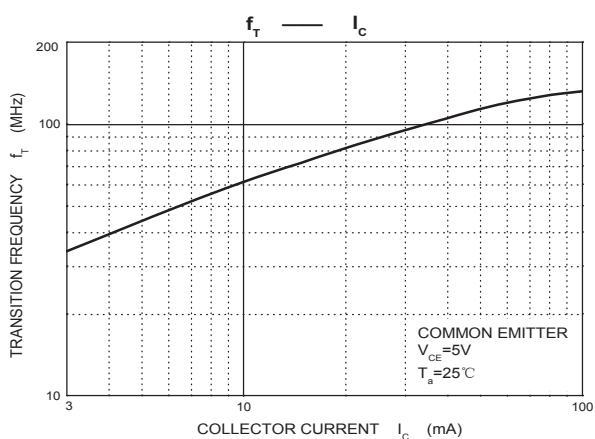
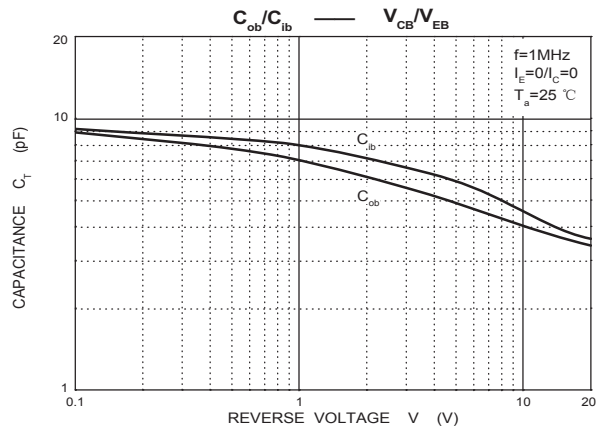
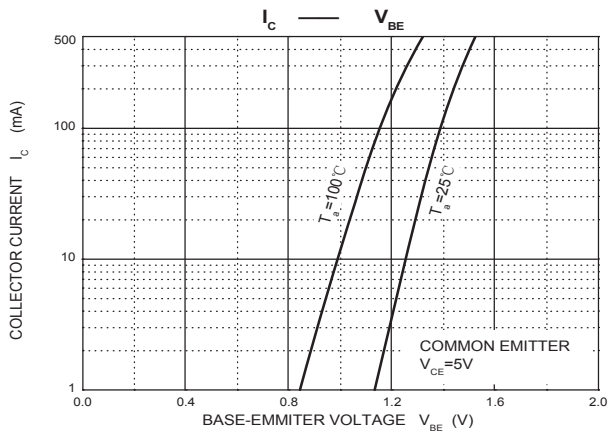
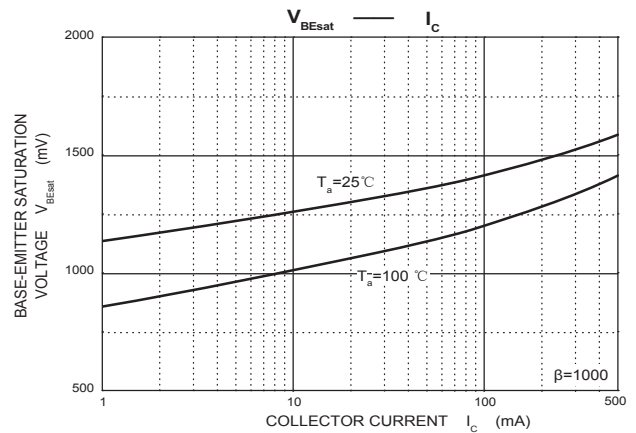
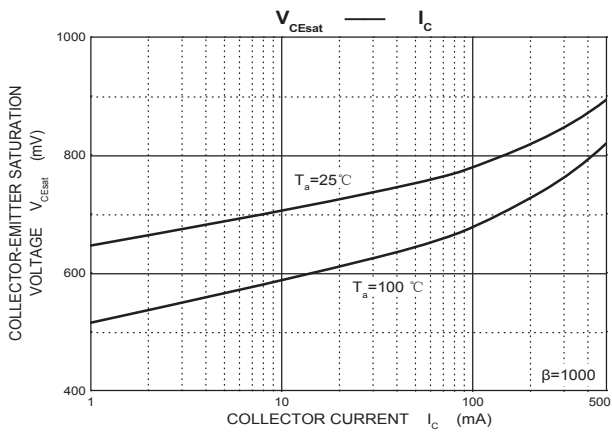
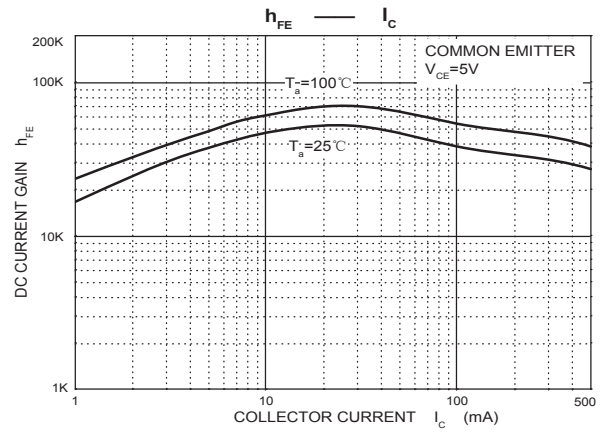
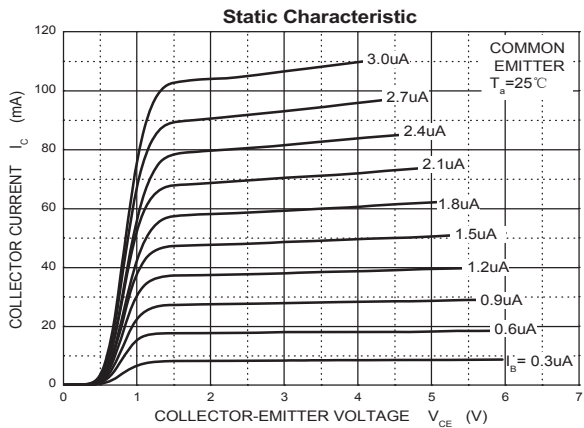

TO-92 PACKAGE TAPEING DIMENSION

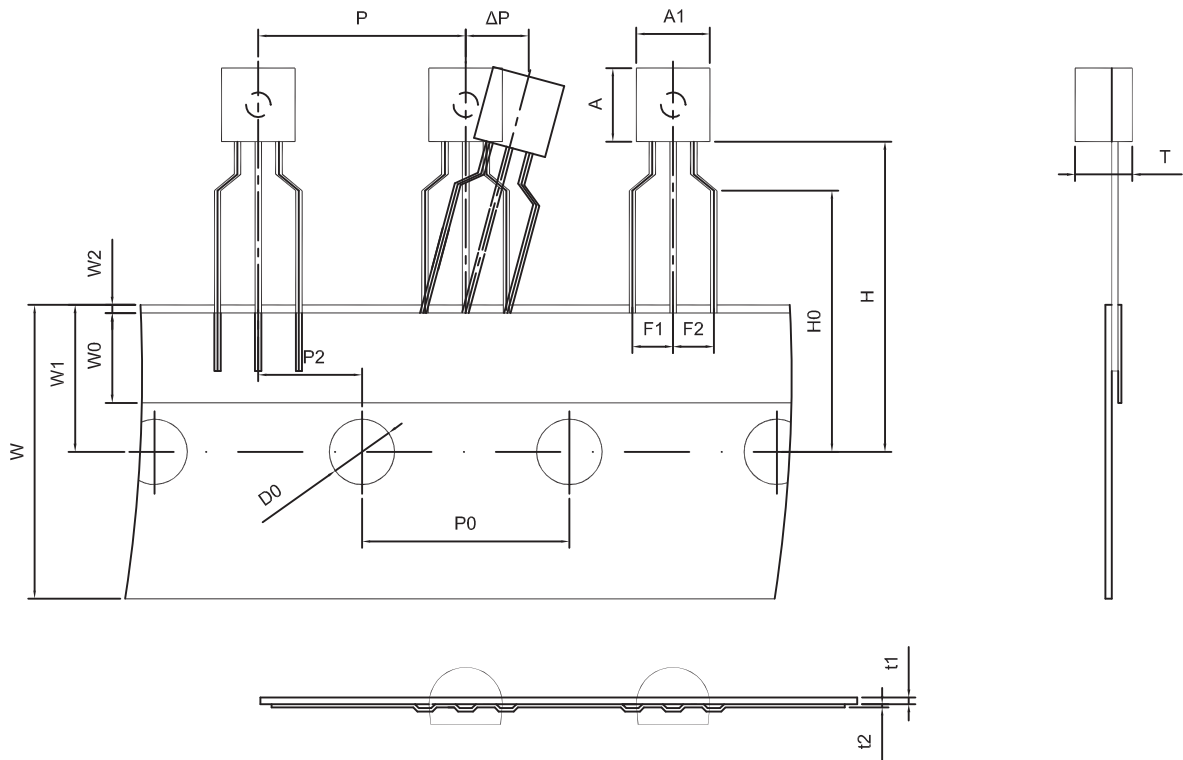

Dimensions are in millimeter

A1	A	T	P	P0	P2	F1	F2	W
4.5	4.5	3.5	12.7	12.7	6.35	2.5	2.5	18.0
W0	W1	W2	H	H0	D0	t1	t2	ΔP
6.0	9.0	1.0 MAX.	19.0	16.0	4.0	0.4	0.2	0

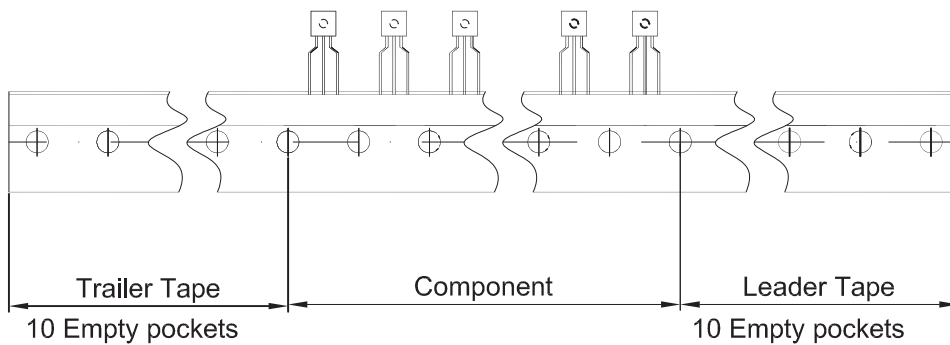

Package	Box	Box Size(mm)	Carton	Carton Size(mm)
TO-92	2000 pcs	333×162×43	20,000 pcs	350×340×250