

TO-92 Plastic-Encapsulate Transistors

FEATURES

- General Purpose Amplifier
- TRANSISTOR (PNP)

MECHANICAL DATA

- Case style:TO-92 molded plastic
- Mounting position:any

TO-92

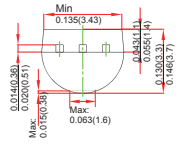
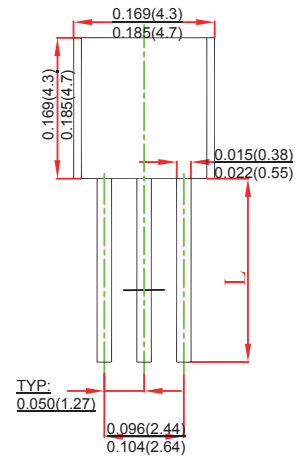

MAXIMUM RATINGS AND CHARACTERISTICS

@ 25°C Ambient Temperature (unless otherwise noted)

Symbol	Parameter	Value	Unit
V_{CB0}	Collector-Base Voltage	-60	V
V_{CE0}	Collector-Emitter Voltage	-60	V
V_{EB0}	Emitter-Base Voltage	-4	V
I_C	Collector Current -Continuous	-0.5	A
P_D	Collector Power Dissipation	625	mW
$R_{\theta JA}$	Thermal Resistance from Junction to Ambient	200	°C / W
T_j	Junction Temperature	150	°C
T_{stg}	Storage Temperature	-55 ~ +150	°C

ORDERING INFORMATION

Part Number	Package	Packing Method	Pack Quantity
MPSA55	TO-92	Bulk	1000pcs/Bag
MPSA55-TA	TO-92	Tape	2000pcs/Box

Parameter	Symbol	Test conditions	Min	Typ	Max	Unit
Collector-base breakdown voltage	$V_{(BR)CB0}$	$I_C = -0.1mA, I_E = 0$	-60			V
Collector-emitter breakdown voltage	$V_{(BR)CE0}$	$I_C = -1mA, I_B = 0$	-60			V
Emitter-base breakdown voltage	$V_{(BR)EB0}$	$I_E = -0.1mA, I_C = 0$	-4			V
Collector cut-off current	I_{CBO}	$V_{CB} = -60V, I_E = 0$			-0.1	KA
Collector cut-off current	I_{CEO}	$V_{CE} = -60V, I_B = 0$			-0.1	KA
Emitter cut-off current	I_{EBO}	$V_{EB} = -4V, I_C = 0$			-0.1	KA
DC current gain	$h_{FE(1)}$	$V_{CE} = -1V, I_C = -10mA$	100			
	$h_{FE(2)}$	$V_{CE} = -1V, I_C = -100mA$	100			
Collector-emitter saturation voltage	$V_{CE(sat)}$	$I_C = -100mA, I_B = -10mA$			-0.25	V
Base-emitter on voltage	V_{BE}	$I_C = -100mA, V_{CE} = -1V$			-1.2	V
Transition frequency	f_T	$V_{CE} = -1V, I_C = -100mA, f = 100MHz$	50			MHz

Marking	MPSA55
---------	--------

Typical Characteristics

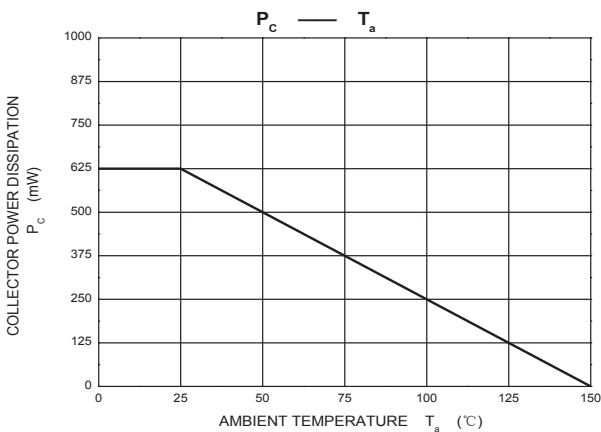
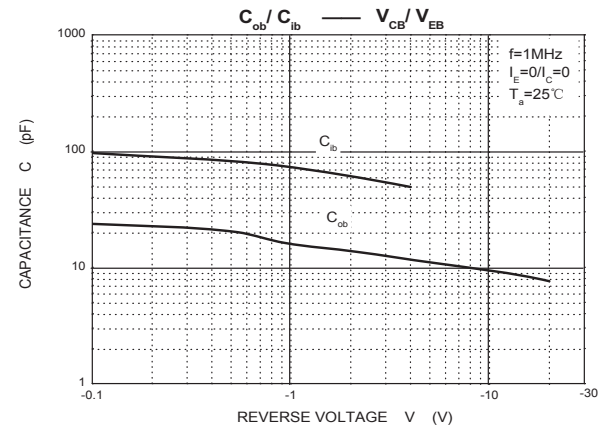
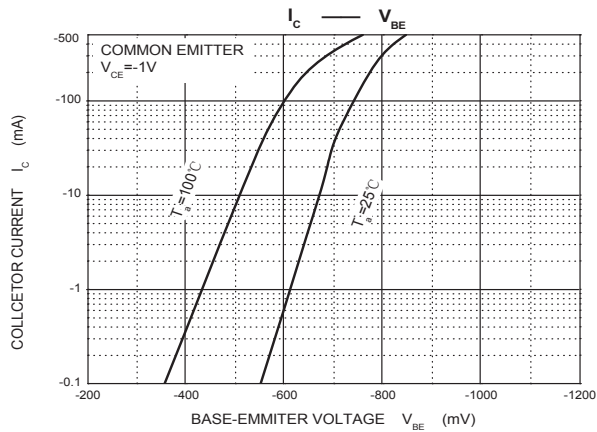
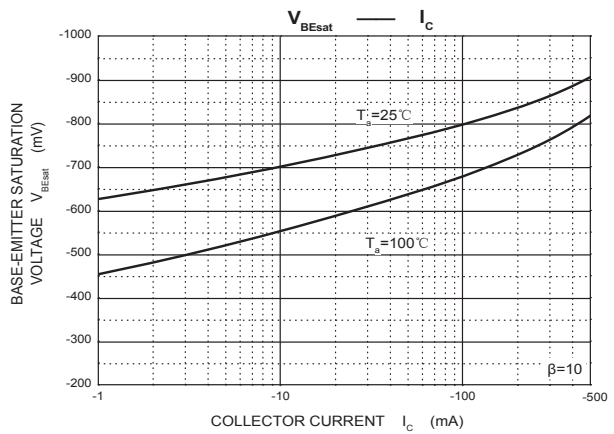
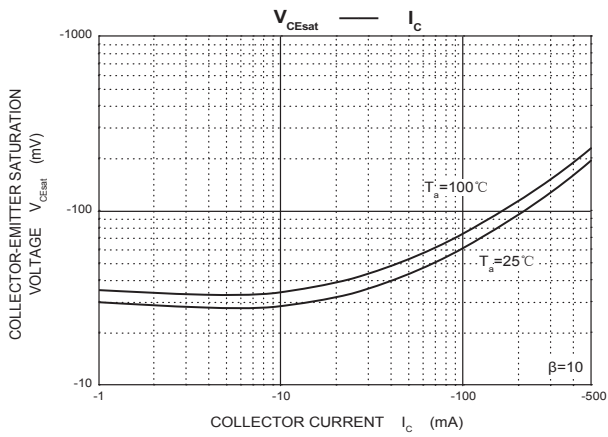
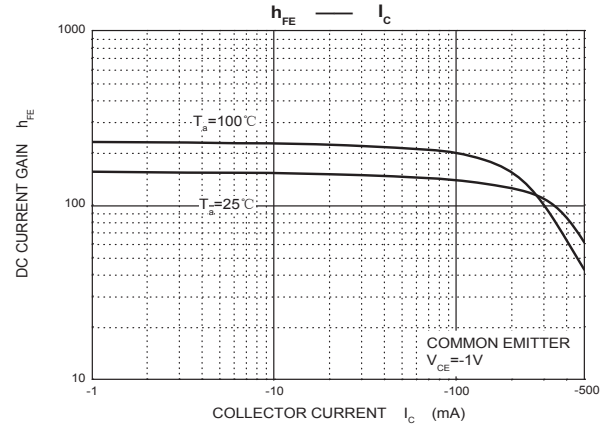
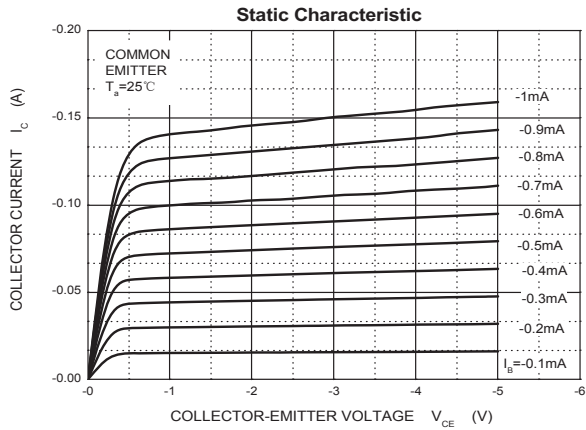

TO-92 PACKAGE TAPEING DIMENSION

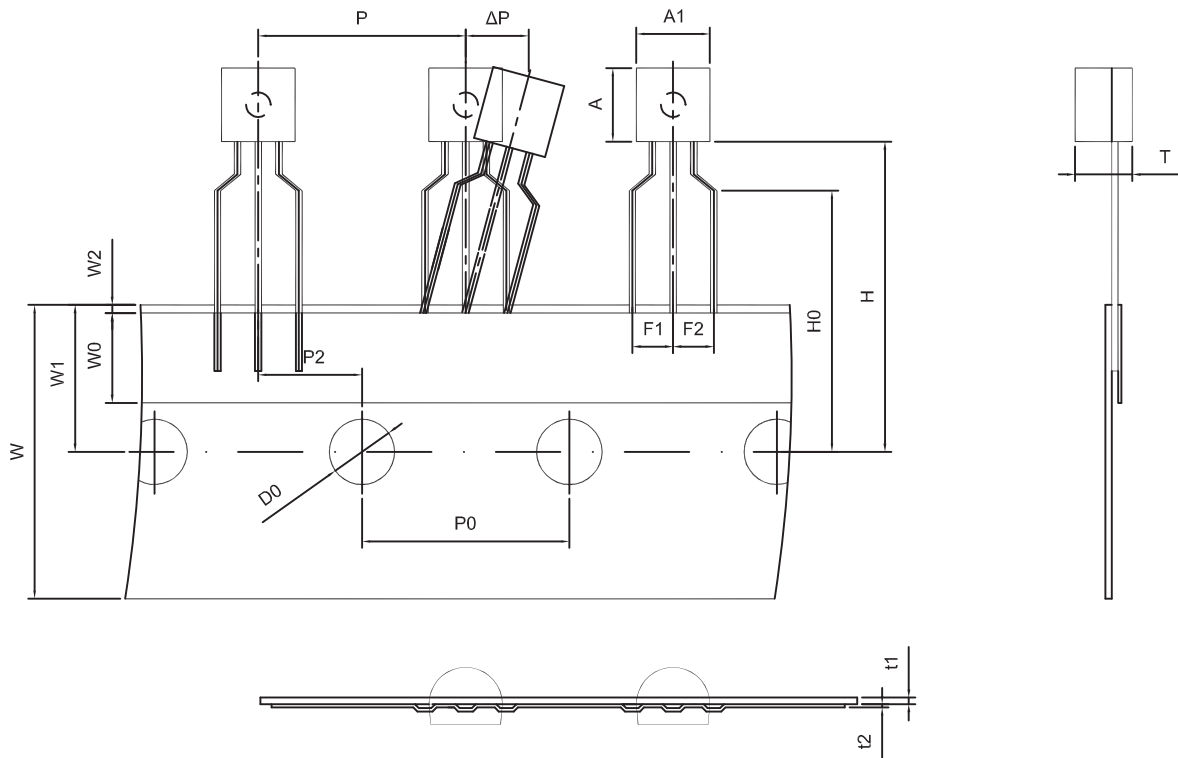

Dimensions are in millimeter								
A1	A	T	P	P0	P2	F1	F2	W
4.5	4.5	3.5	12.7	12.7	6.35	2.5	2.5	18.0
W0	W1	W2	H	H0	D0	t1	t2	ΔP
6.0	9.0	1.0 MAX.	19.0	16.0	4.0	0.4	0.2	0

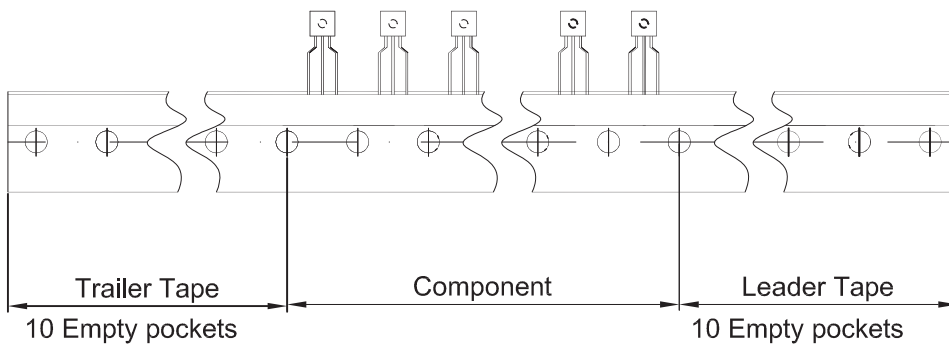

Package	Box	Box Size(mm)	Carton	Carton Size(mm)
TO-92	2000 pcs	333×162×43	20,000 pcs	350×340×250