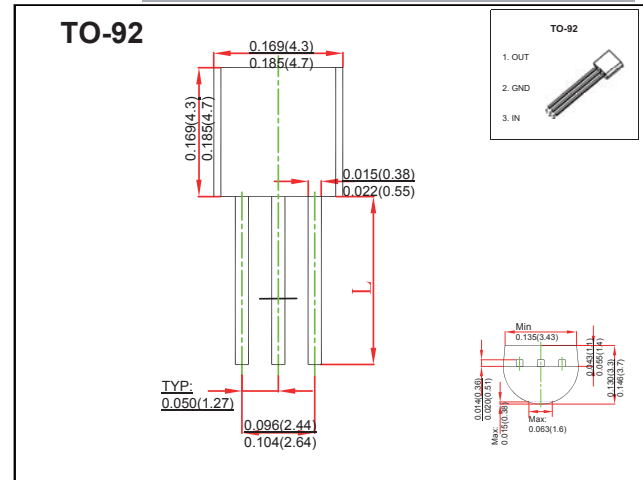

Voltage Regulators
**VOLTAGE : 37V
POWER DISSIPATION:770mW**
Features

- The output voltage can be adjusted to 36V
- Low dynamic output impedance, its typical value is 0.2
- Trapping current capability is 1 to 100mA
- The typical value of the equivalent temperature factor in the whole temperature scope is 50 ppm/
- The effective temperature compensation in the working range of full temperature
- Low output noise voltage
- Fast on-state response

MECHANICAL DATA

- Case: TO-92 Small Outline Plastic Package
- Polarity: Color band denotes cathode end
- Mounting Position: Any

MAXIMUM RATINGS AND CHARACTERISTICS

@ 25°C Ambient Temperature (unless otherwise noted)

Parameter	□□□ □□□	V□□□	□□□□U□□□
Cathode Voltage	V_{KA}	37	V
Cathode Current Range (Continuous)	I_{KA}	-100~+150	mA
Reference Input Current Range	I_{ref}	0.05~+10	mA
Power Dissipation	P_D	770	mW
Thermal Resistance from Junction to Ambient	$R_{\theta JA}$	162	°C/W
Operating Ambient Temperature Range	T_{opr}	0~+70	°C
Storage Temperature Range	T_{stg}	-65~+150	°C
Operating Junction Temperature	T_j	150	°C

Electrical Specification ($T_A=25^\circ\text{C}$ unless otherwise specified)

Parameter	Symbol	Test conditions	Min	Typ	Max	Unit
Reference Input Voltage (Fig.1)	V_{ref}	$V_{KA}=V_{REF}, I_{KA}=10\text{mA}$	2.450	2.5	2.550	V
Deviation of Reference Input Voltage Over Temperature (note) (Fig.1)	$\Delta V_{ref}/\Delta T$	$V_{KA}=V_{REF}, I_{KA}=10\text{mA}$ $T_{min}\leq T_A\leq T_{max}$		4.5	17	mV
Ratio Of Change in Reference Input Voltage to the Change in Cathode Voltage (Fig.2)	$\Delta V_{ref}/\Delta V_{KA}$	$I_{KA}=10\text{mA}$ $\Delta V_{KA}=10\text{V}\sim V_{REF}$		-1.0	-2.7	mV/V
		$\Delta V_{KA}=36\text{V}\sim 10\text{V}$		-0.5	-2.0	mV/V
Reference Input Current (Fig.2)	I_{ref}	$I_{KA}=10\text{mA}, R_1=10\text{k}\Omega$ $R_2=\infty$		1.5	4	μA
Deviation Of Reference Input Current Over Full Temperature Range (Fig.2)	$\Delta I_{ref}/\Delta T$	$I_{KA}=10\text{mA}, R_1=10\text{k}\Omega$ $R_2=\infty$ $T_A=\text{full Temperature}$		0.4	1.2	μA
Minimum Cathode Current for Regulation (Fig.1)	$I_{KA(min)}$	$V_{KA}=V_{REF}$		0.45	1.0	mA
Off-state Cathode Current (Fig.3)	$I_{KA(OFF)}$	$V_{KA}=36\text{V}, V_{REF}=0$		0.05	1.0	μA
Dynamic Impedance	Z_{KA}	$V_{KA}=V_{REF}, I_{KA}=1\text{ to }100\text{mA}$ $f\leq 1.0\text{kHz}$		0.15	0.5	Ω

 Note: $T_{MIN}=0^\circ\text{C}$, $T_{MAX}=+70^\circ\text{C}$
CLASSIFICATION of V_{ref}

Rank	0.5%	1%
Range	2.487-2.513	2.475-2.525

■ Typical Characteristics

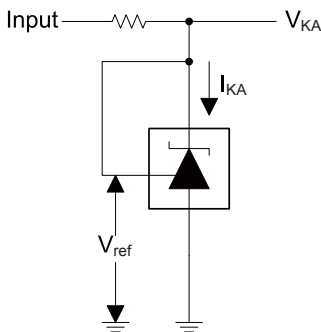
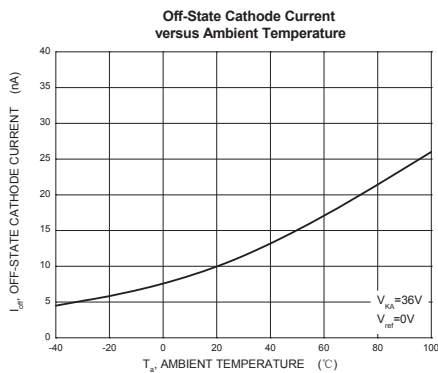
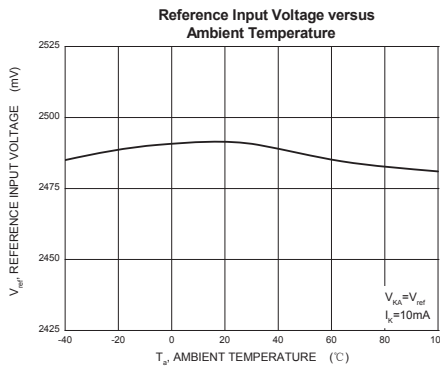
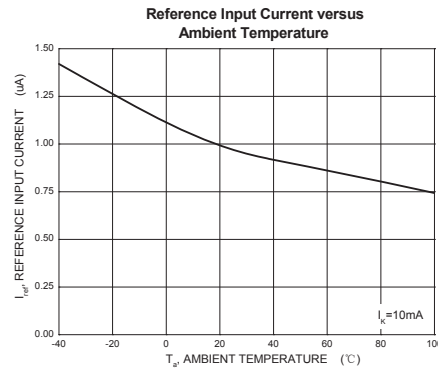
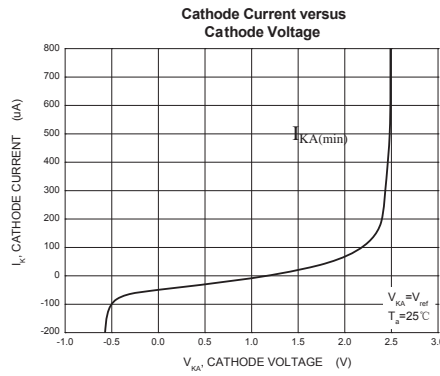
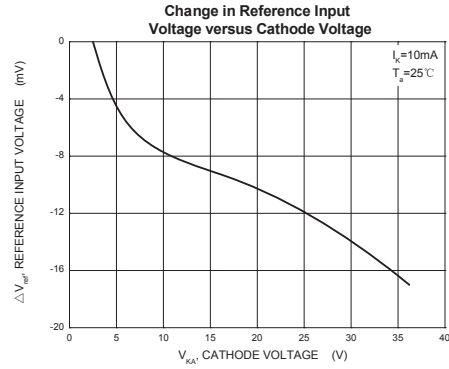
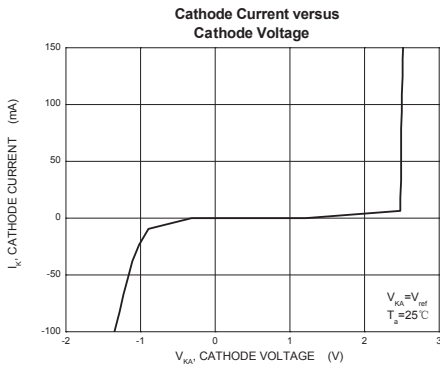

Test Circuit for $V_{KA} = V_{ref}$

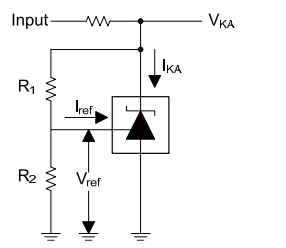

Test Circuit for $V_{KA} = V_{ref}(1 + R1/R2) + R1 * I_{ref}$

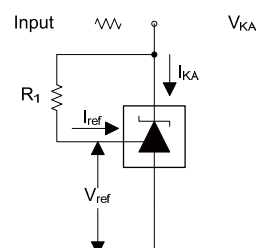

Test Circuit for I_{ref}

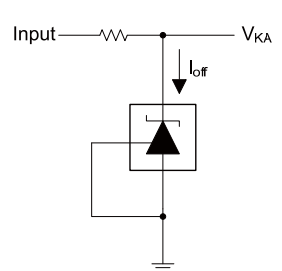

Test Circuit for I_{off}